

NOTE: SF-1 TRANSFERS AIR FROM RM. 2 TO THE LOBBY.

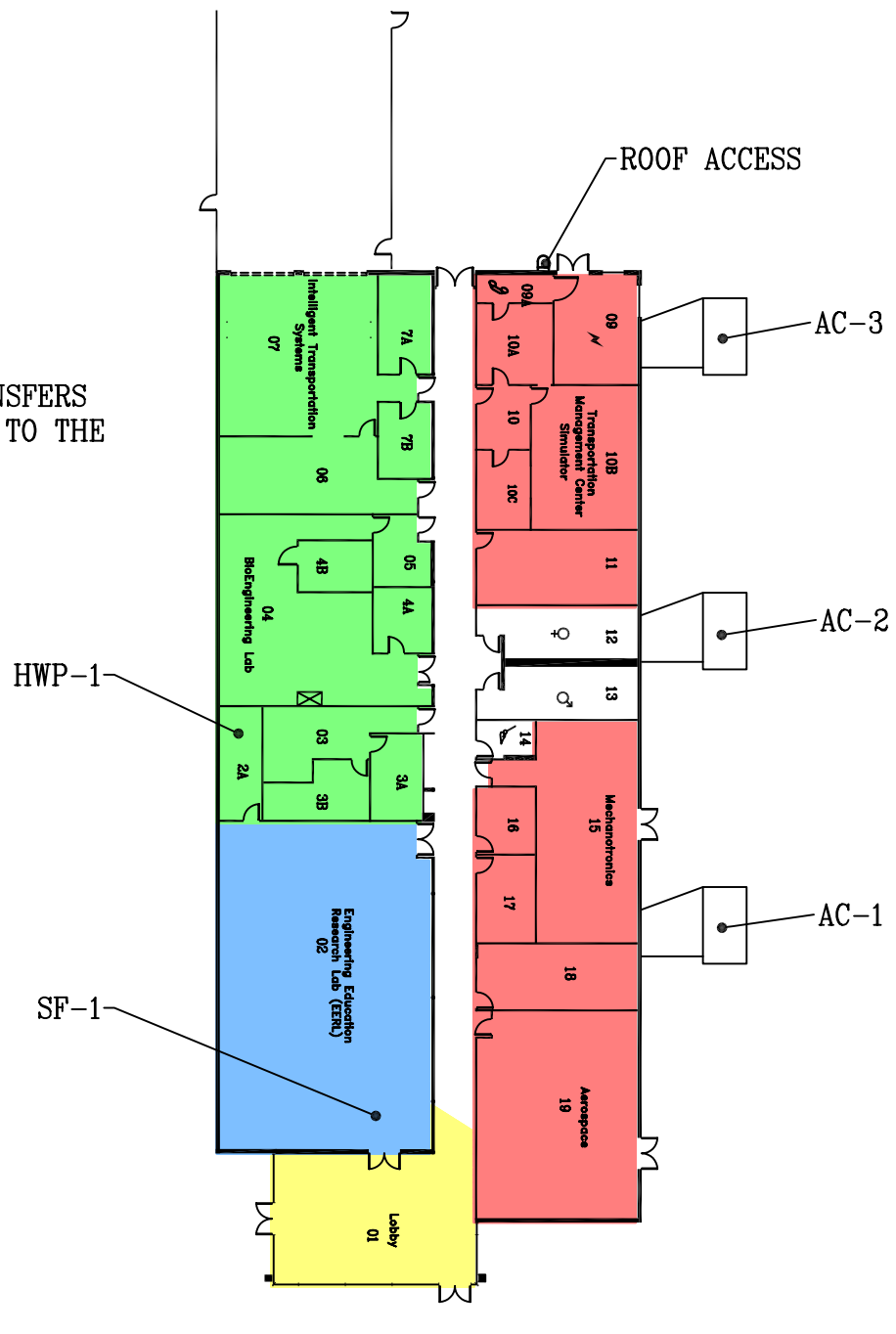

**HEATING & COOLING ZONES**

- AC-1
- AC-2
- AC-3
- SF-1

4/26/02	DATE
	REVISION
mv00705b	FILE
K Hastings	DRAWN
	REVISED

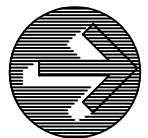

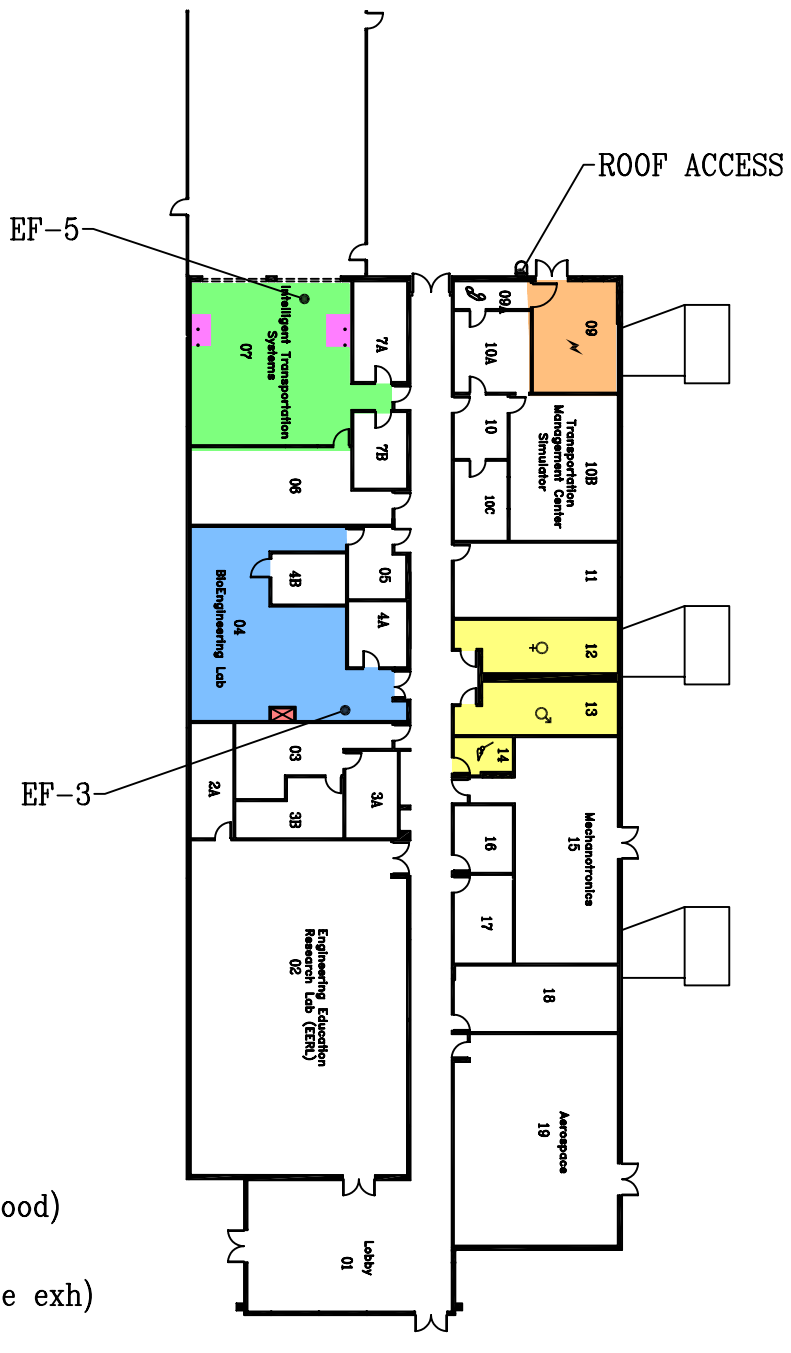

**EXHAUST ZONES**

- EF-1
- EF-2
- EF-3 (fumehood)
- EF-4
- EF-5 (tailpipe exh)
- EF-6

4/5/03	DATE
	REVISION
mv00705b	FILE
k hastings	DRAWN
	REVISED

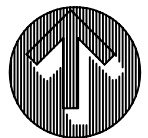

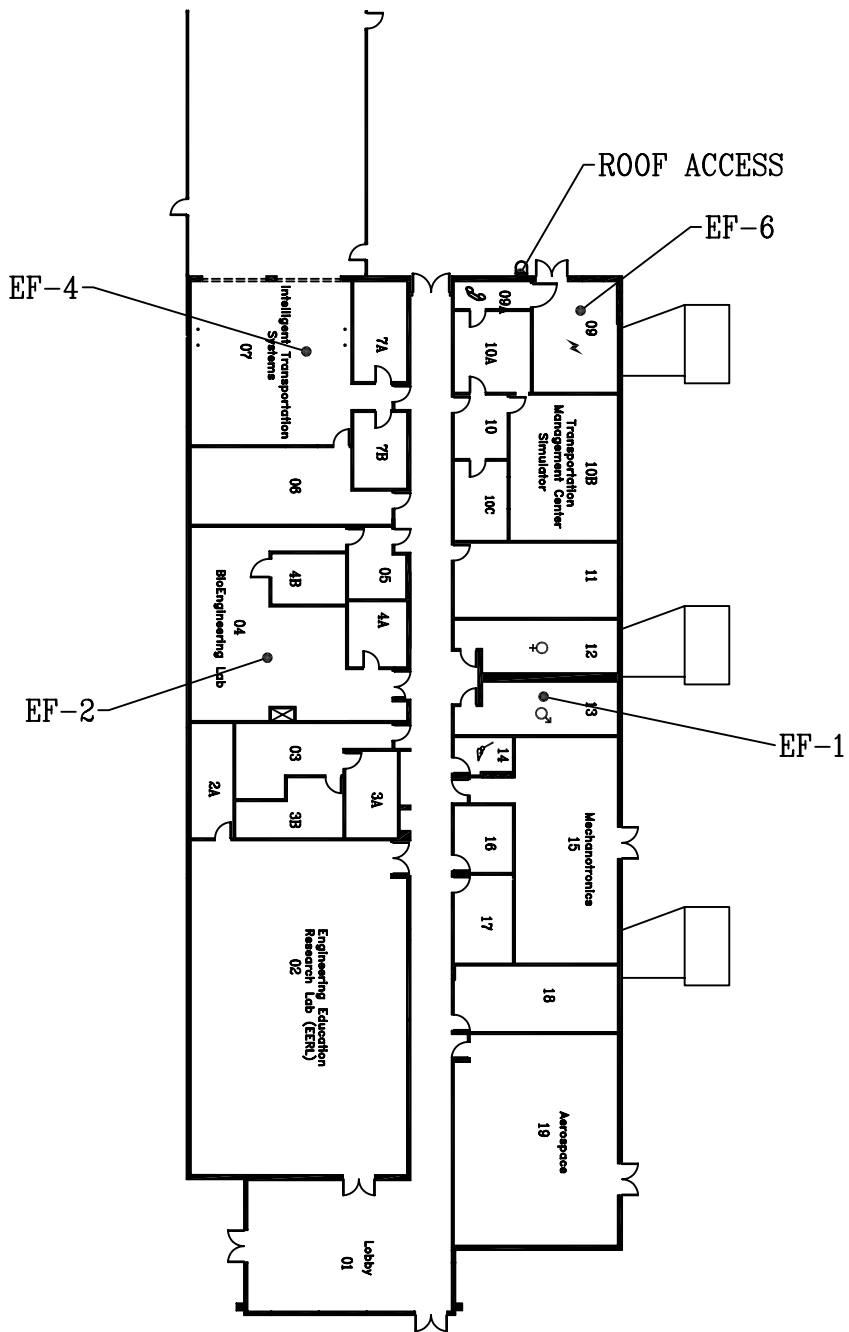

007 Advanced Technologies Lab

Roof Plan  
HVAC Equipment Map - EXHAUST

4/5/03	DATE
3/5/04	REVISION
mv00705b	FILE
BQ	DRAWN
K NAILLON	REVISED

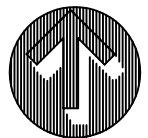

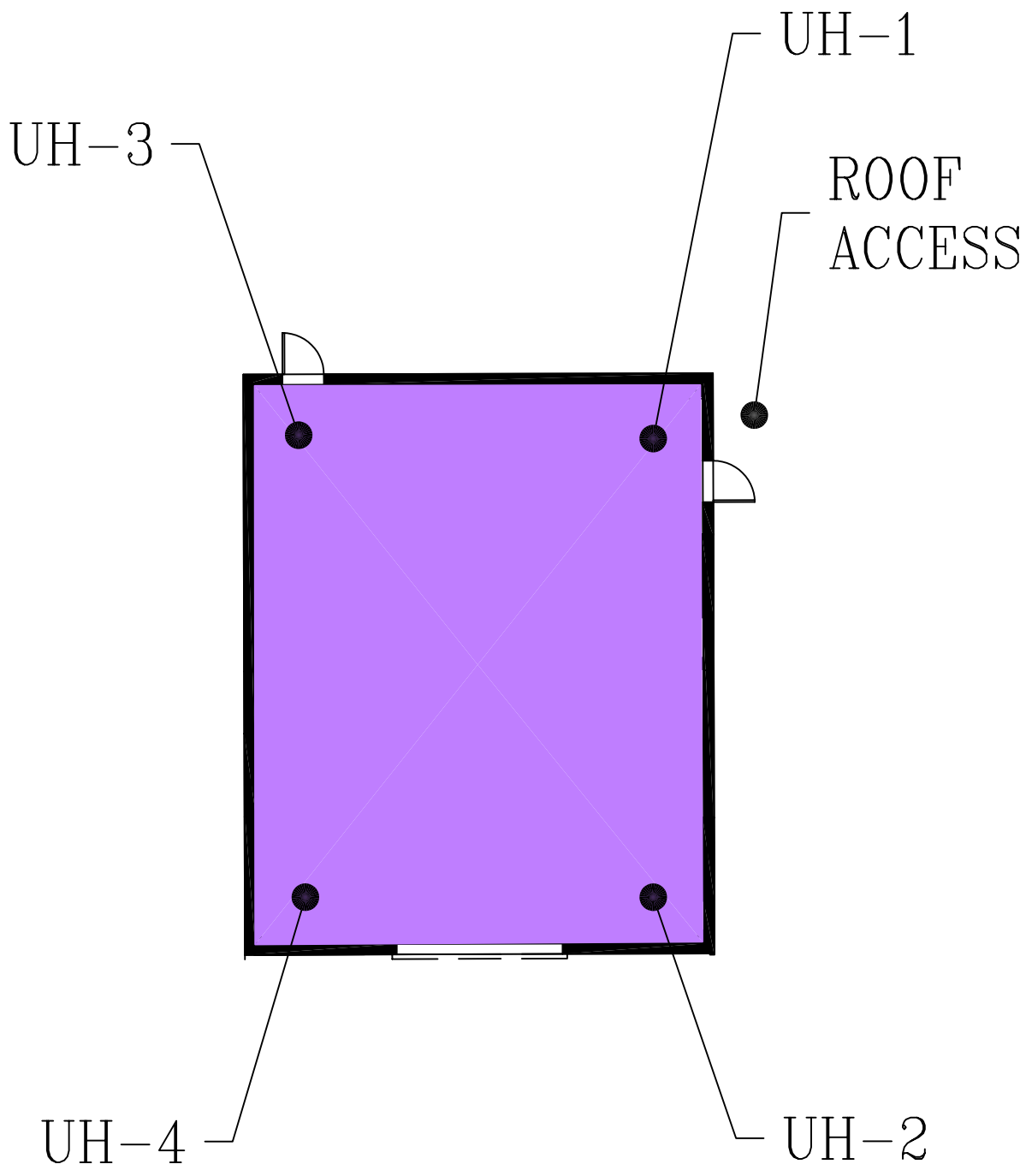

HEATING ZONE

 UH-1,2,3,4

4/5/03	DATE
4/23/04	REVISION
mv007A5b	FILE
k hastings	DRAWN
K Naillon	REVISED



ROOF  
ACCESS

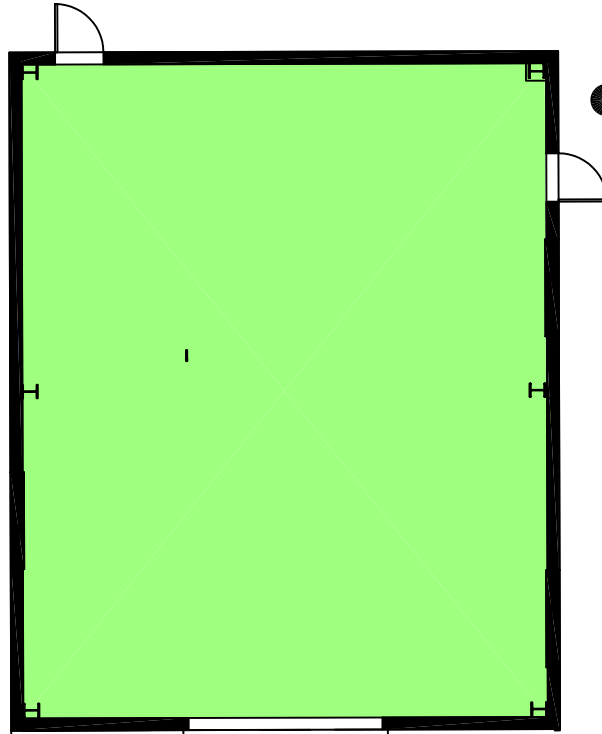

EXHAUST ZONE

 EF-7,EF-8

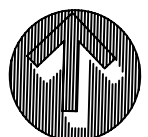

ROOF  
ACCESS

EF-7

EF-8

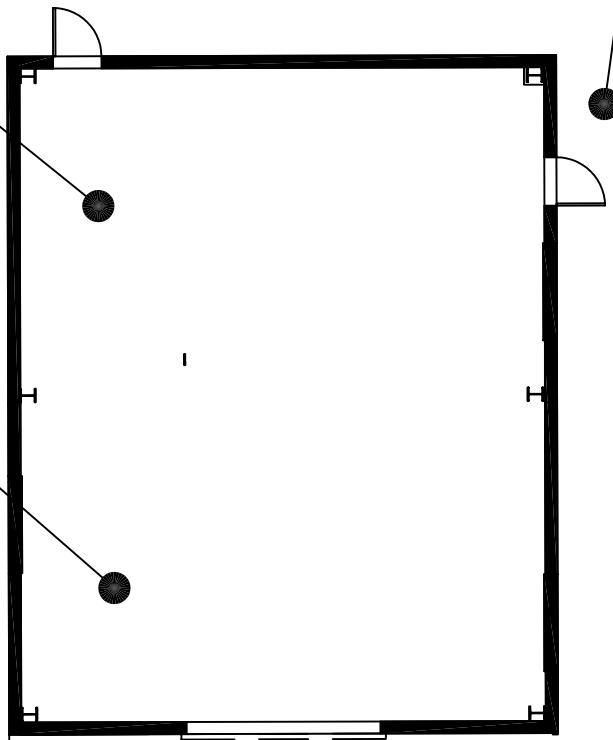

4/5/03	DATE
4/23/04	REVISION
mv007A5b	FILE
k hastings	DRAWN
K Naillon	REVISED

